

ST. SOLDIER INTERNATIONAL CONVENT SCHOOL  
CLASS- NURSERY

NAME: .....



## INSTRUCTIONS

1. Colour the Big Ball Red and Small Ball Yellow.
2. Trace along the dotted line and colour the picture.
3. Trace along the dotted lines and colour the Picture.
4. Trace the dotted line and colour the picture.
5. Join the Dots to make curves.
6. Trace the picture and colour it.
7. Colour the watermelon Red and paste the seeds.
8. Tear the Yellow paper and paste on the given picture.
9. Trace the circles and colour it.
10. Draw the line to make pair.
11. Do the finger printing with Yellow water colour in the tie on father's day.
12. Find the Path
13. Lady finger printing with green water colour.

ENJOY DIFFERENT COLOUR IN DIFFERENT SIZE

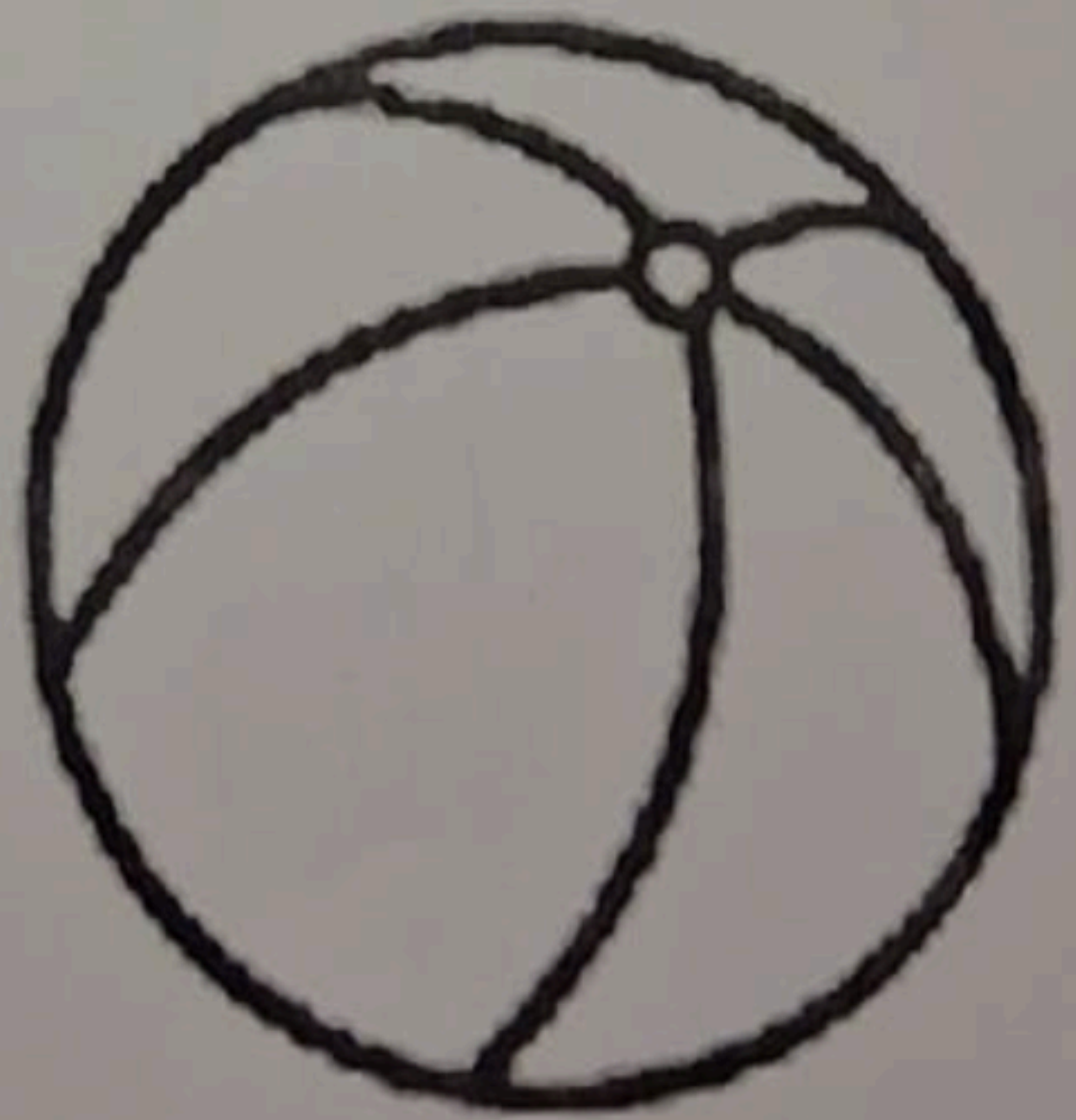
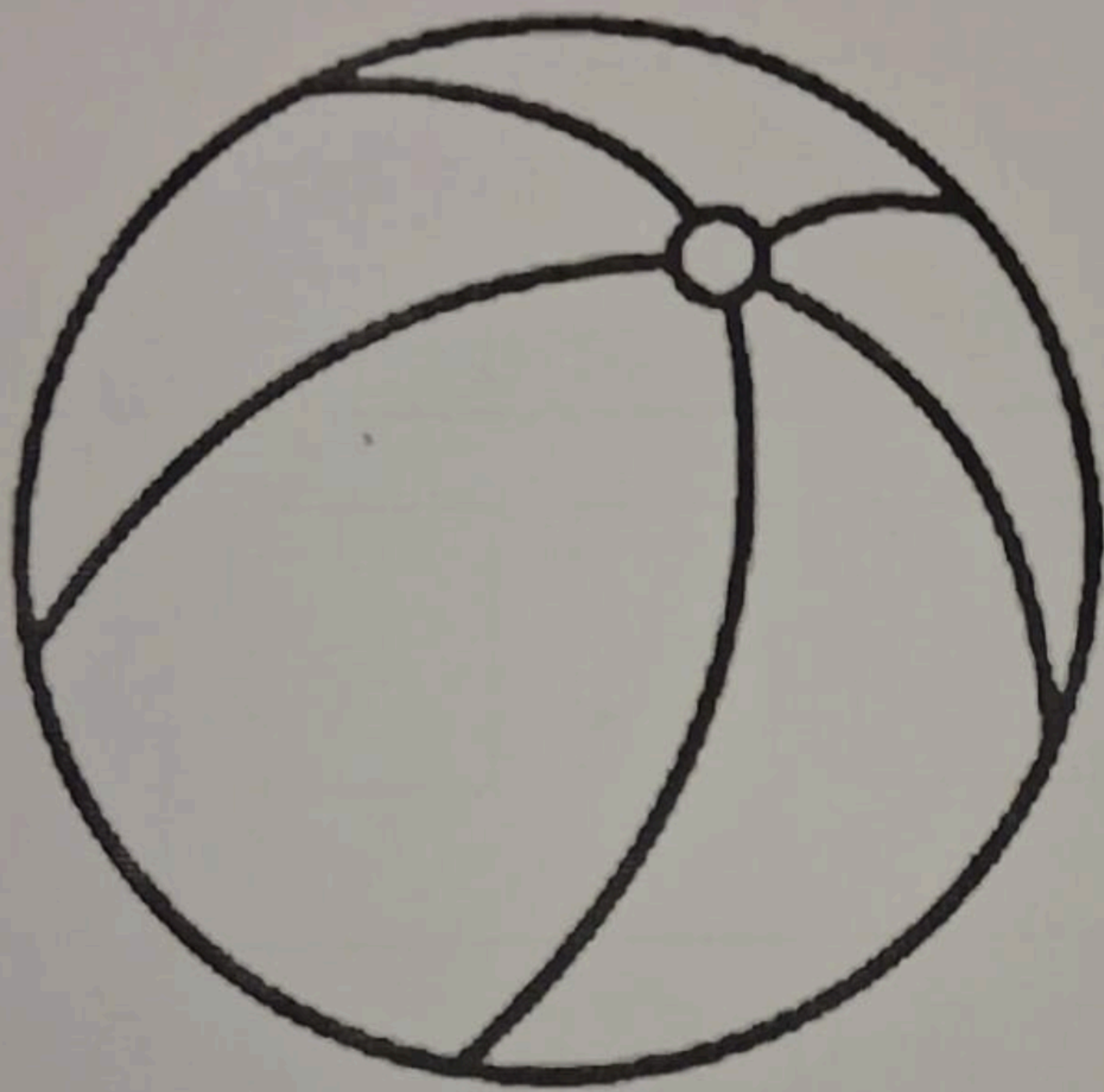

# Standing Lines

Trace along the dotted line and color the picture.

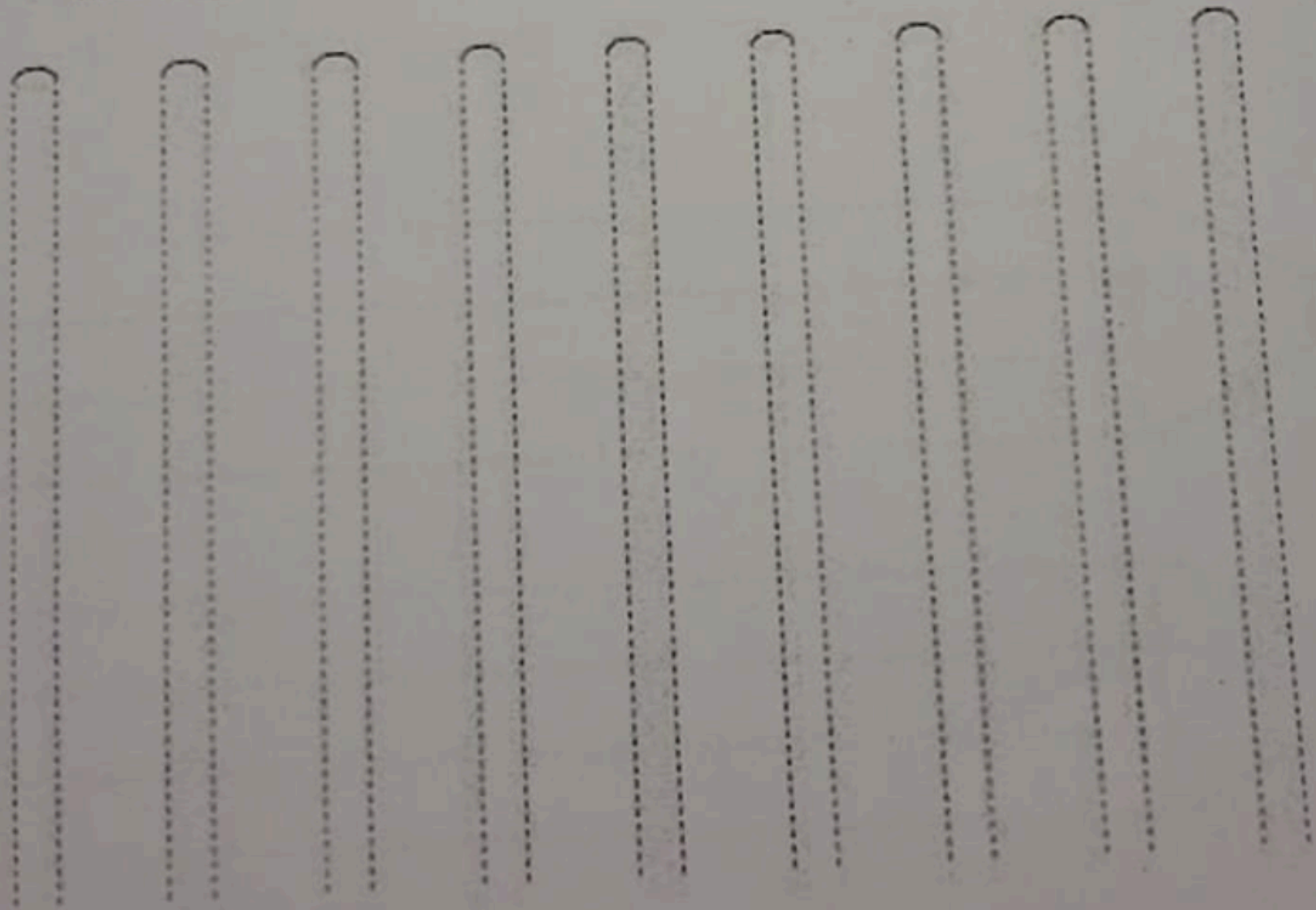
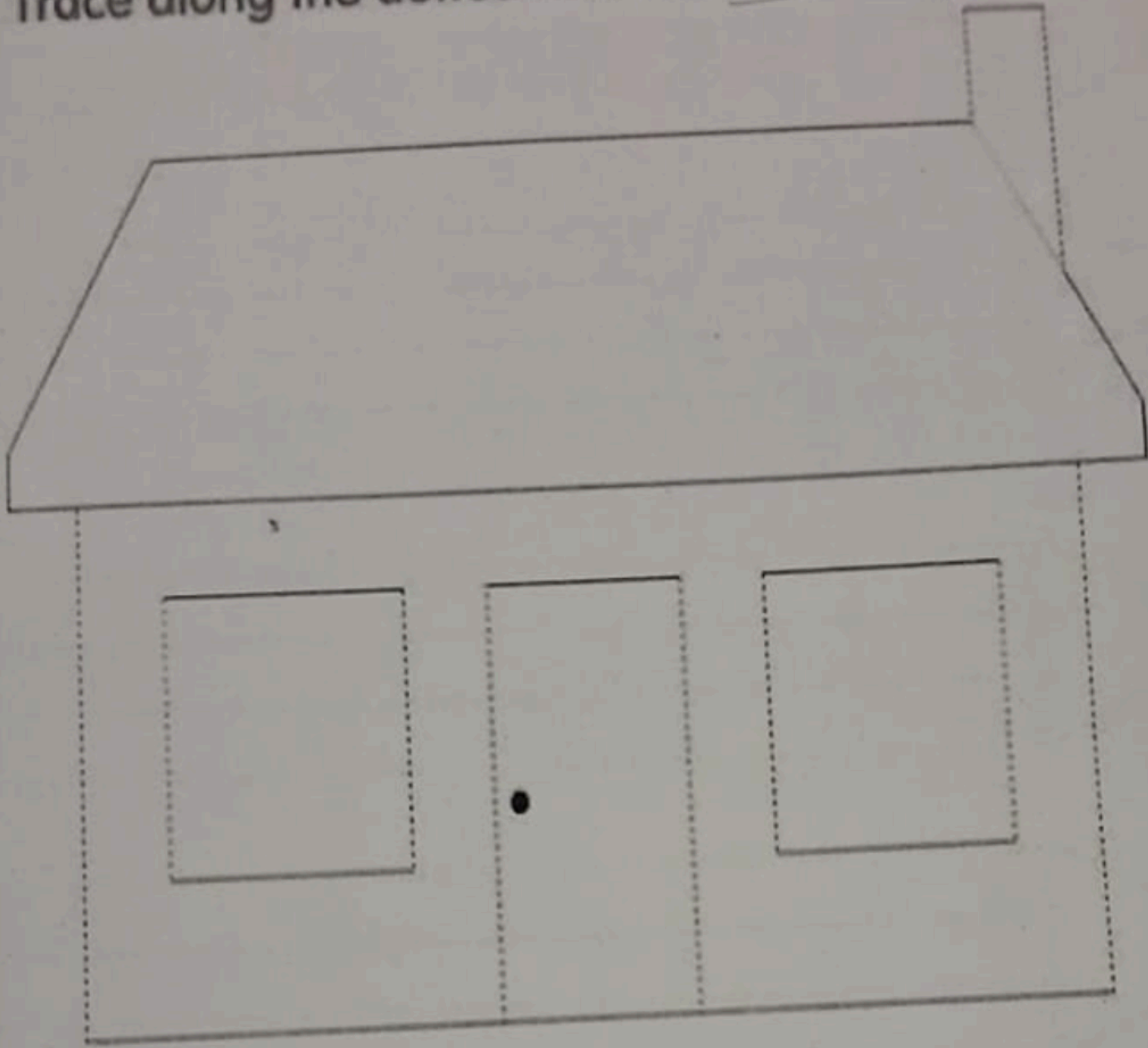

Join the dots and color the Pencil.

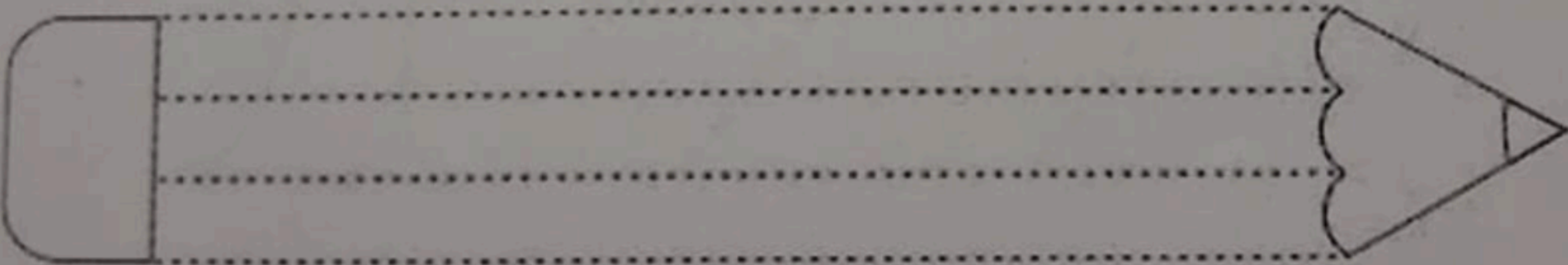
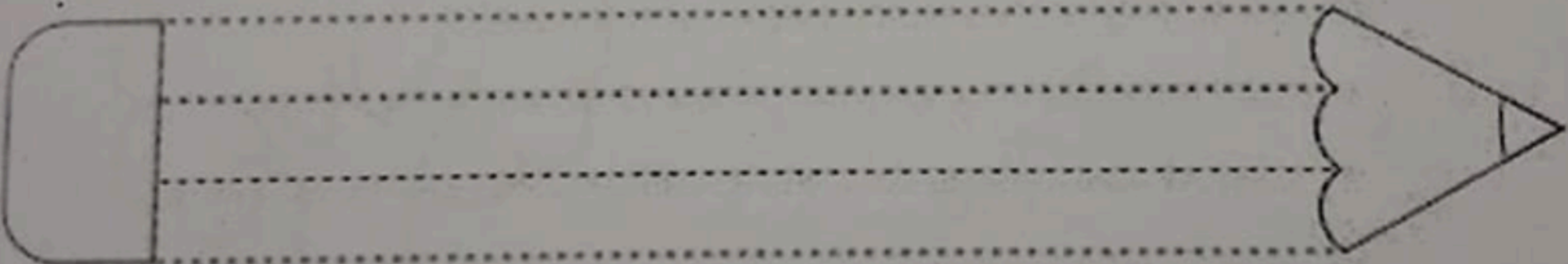
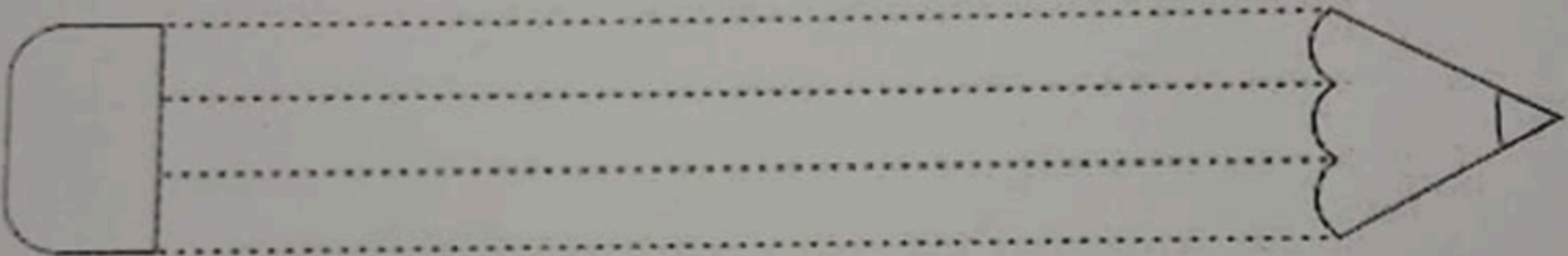
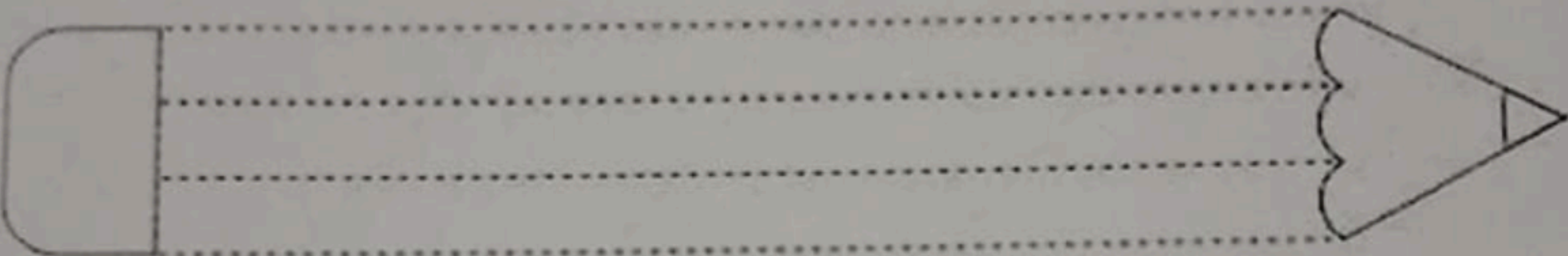
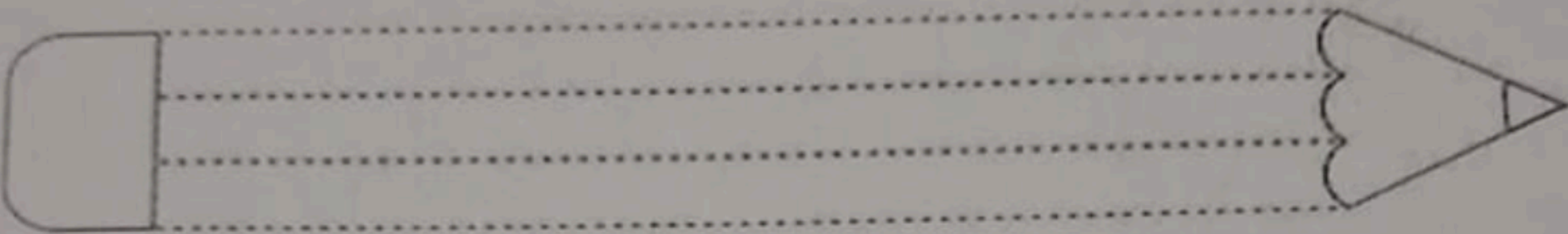
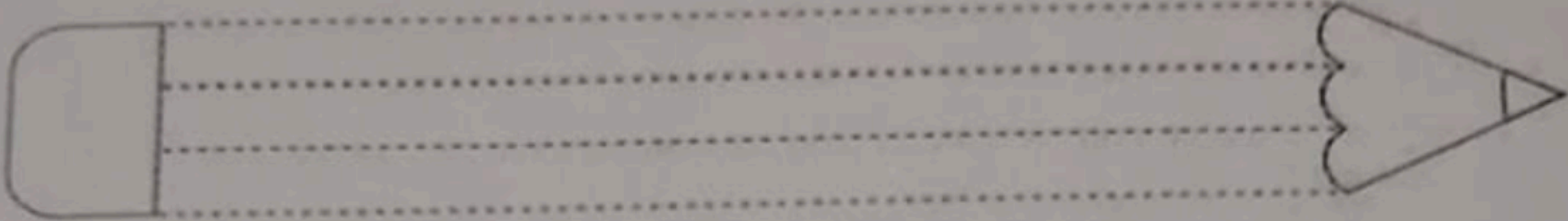

TRACE THE SLANTING LINES AND COLOUR THE PICTURE

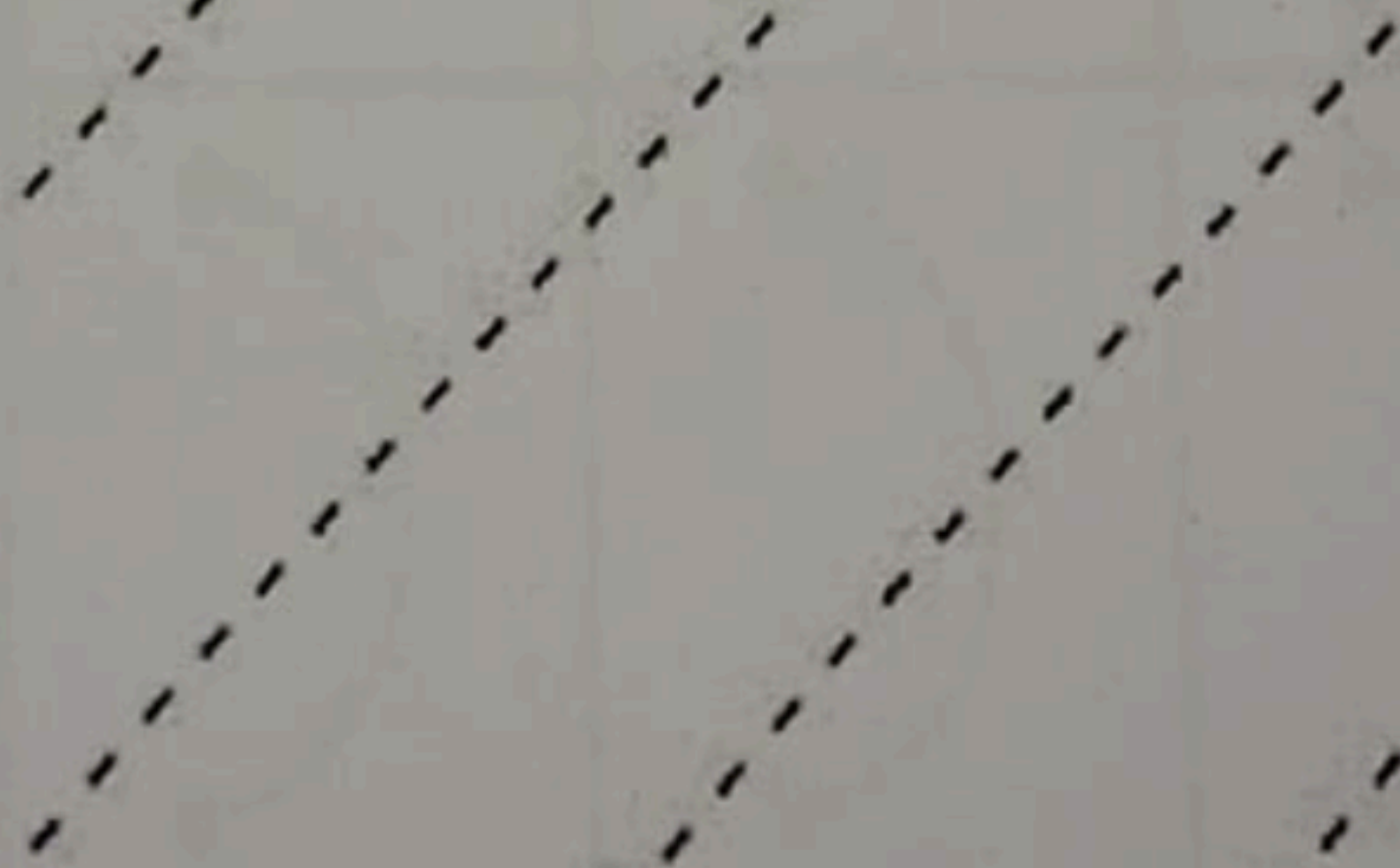
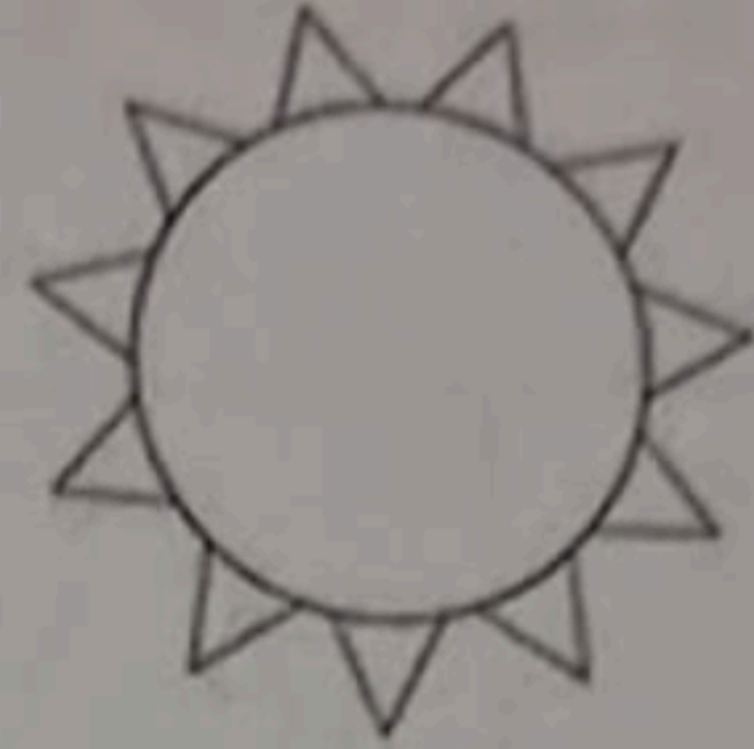
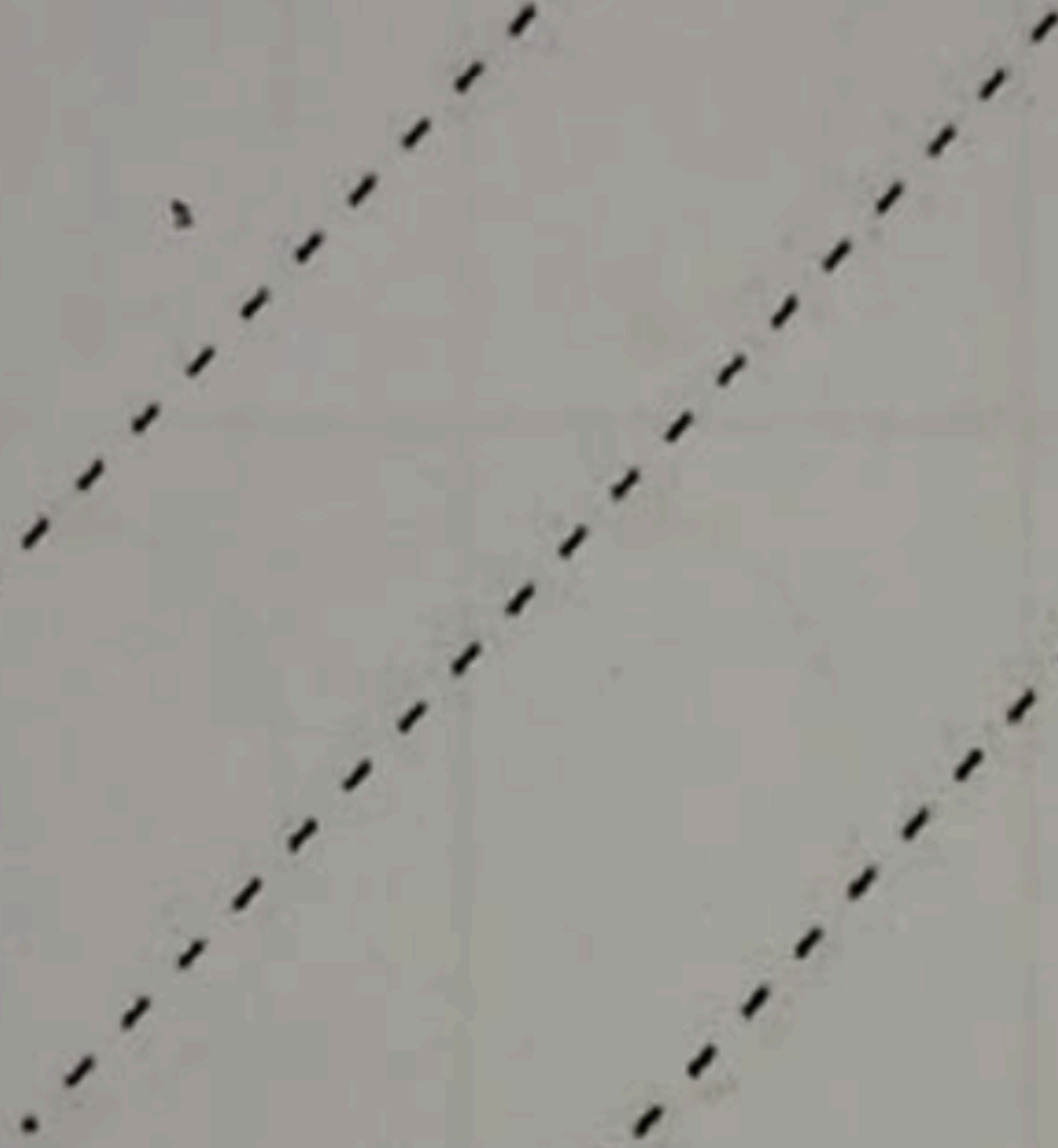
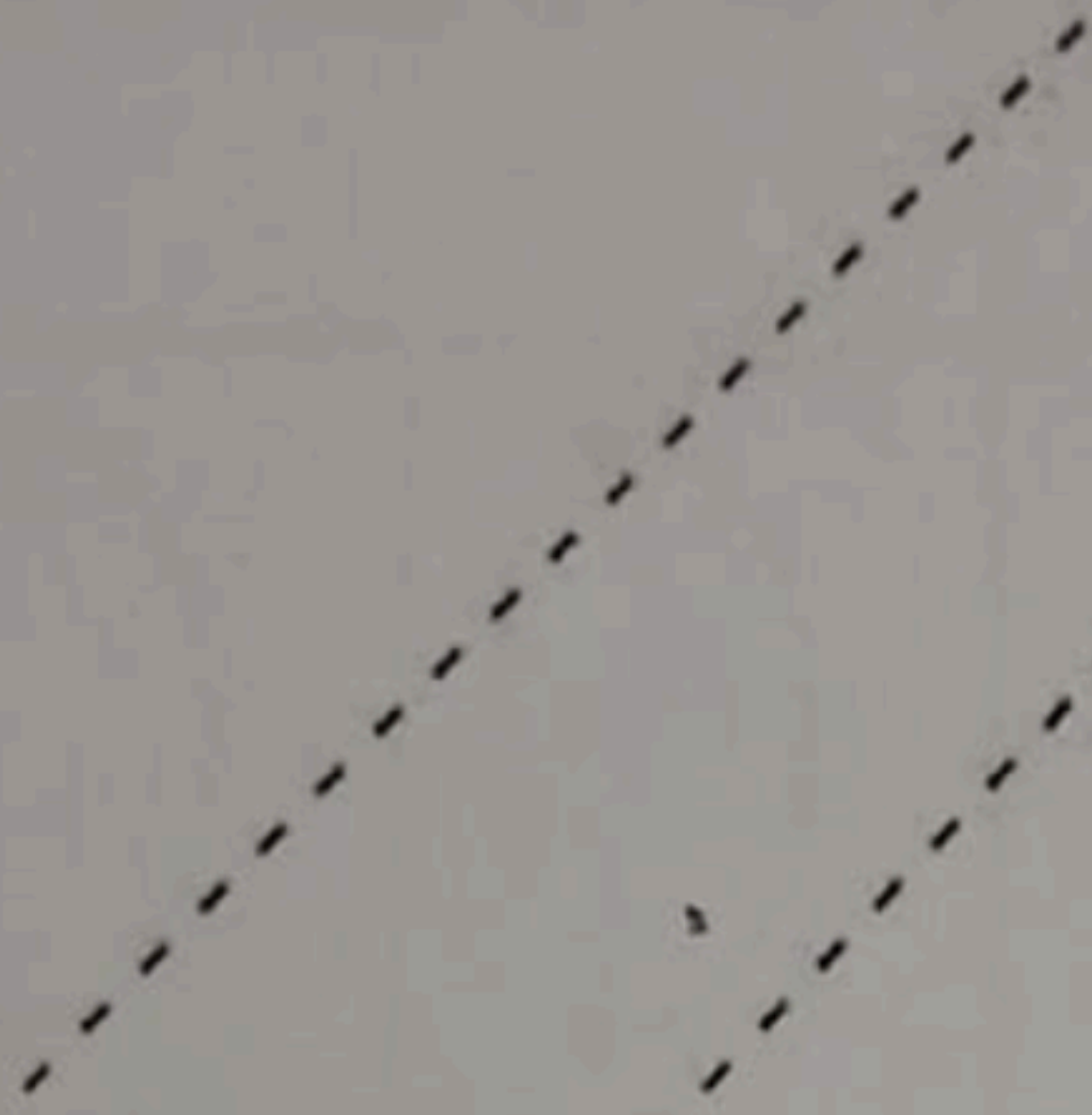

# Tracing Pattern

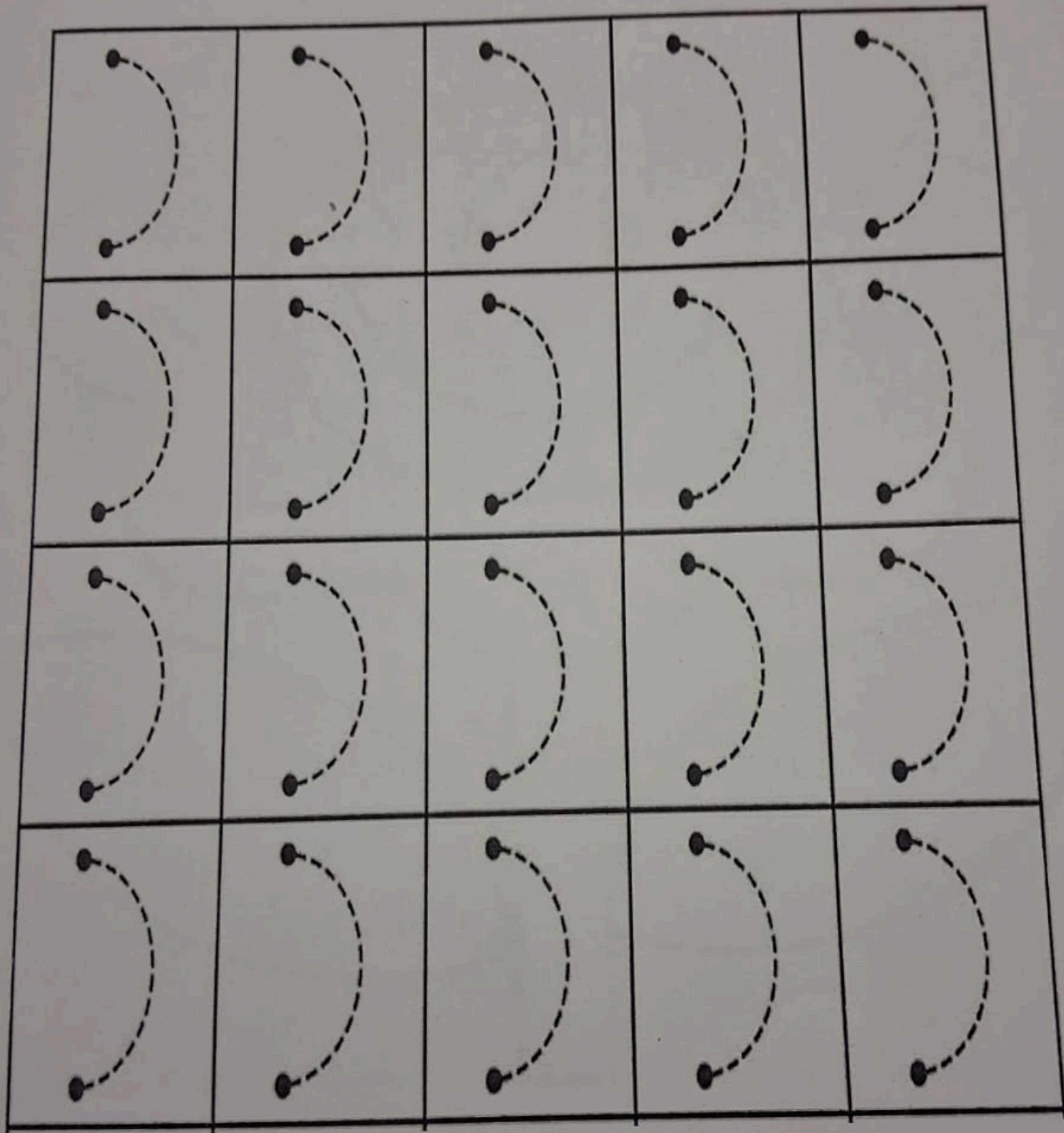

**TRACE THE CURVES**



ENJOY THE SUMMER FRUIT AND USE THE SEEDS

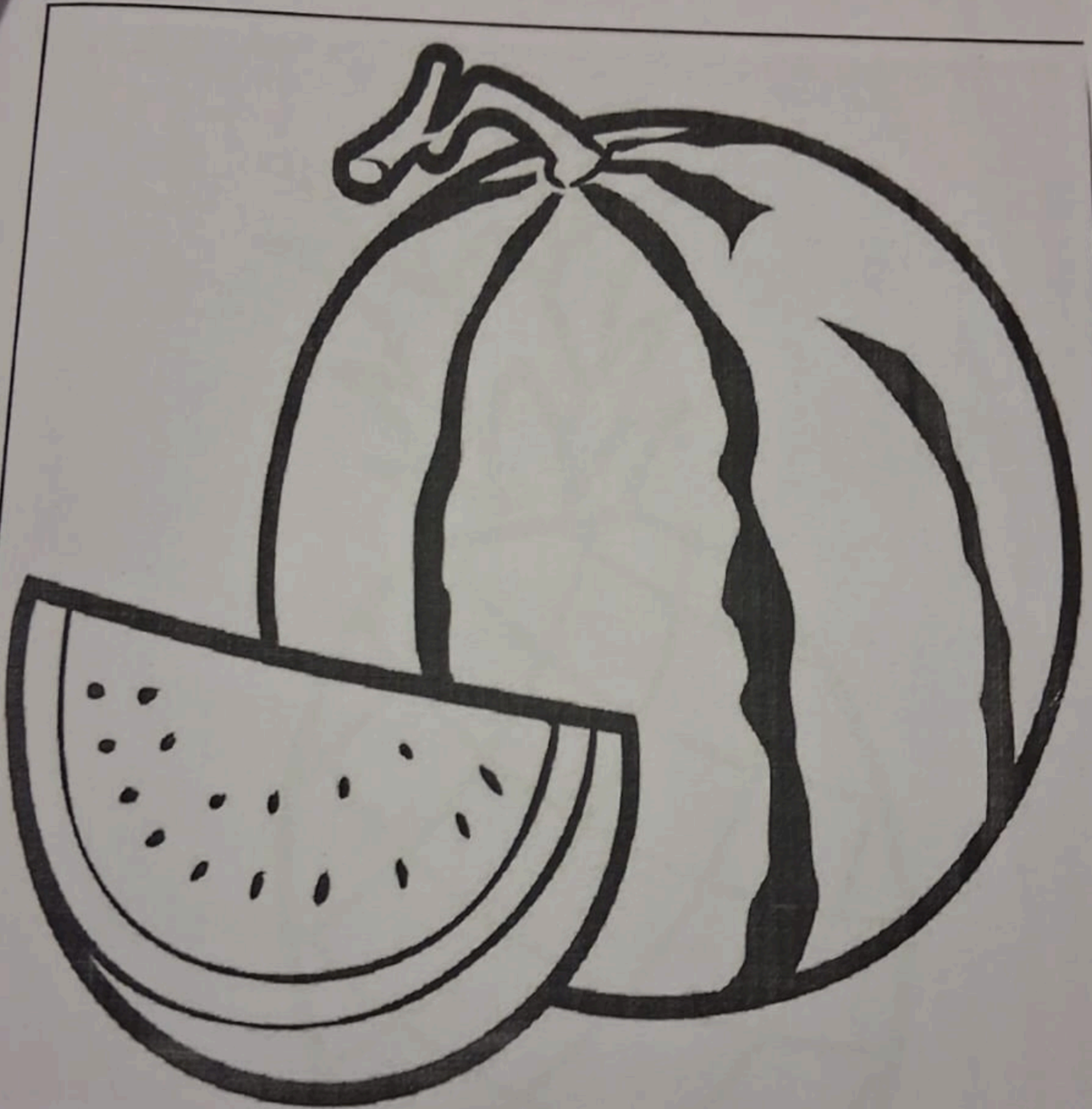

TEARING AND PASTING IS FUN

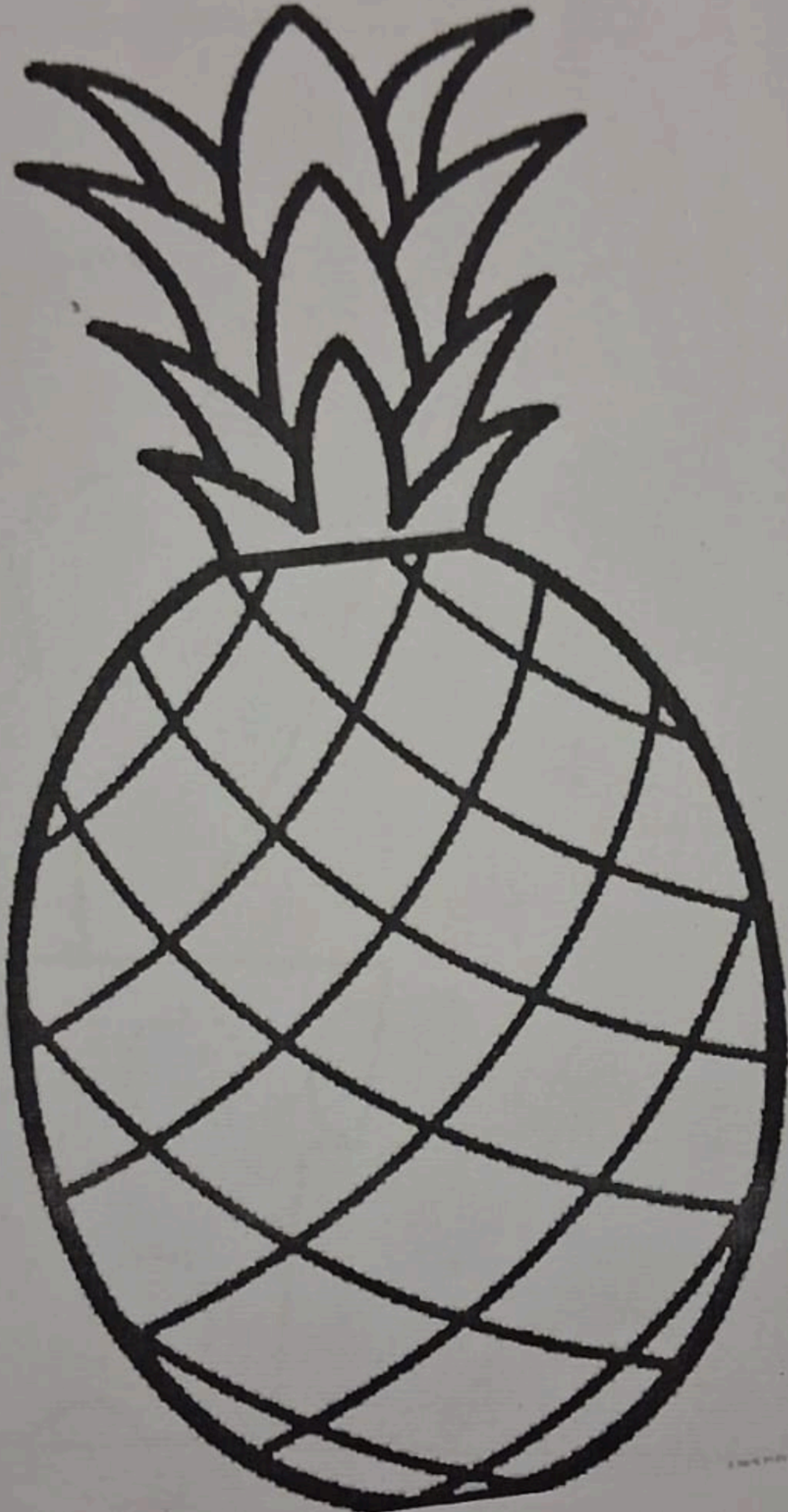

# TRACE THE CIRCLES

## Circle Shape

Find. Trace. Color. Count.

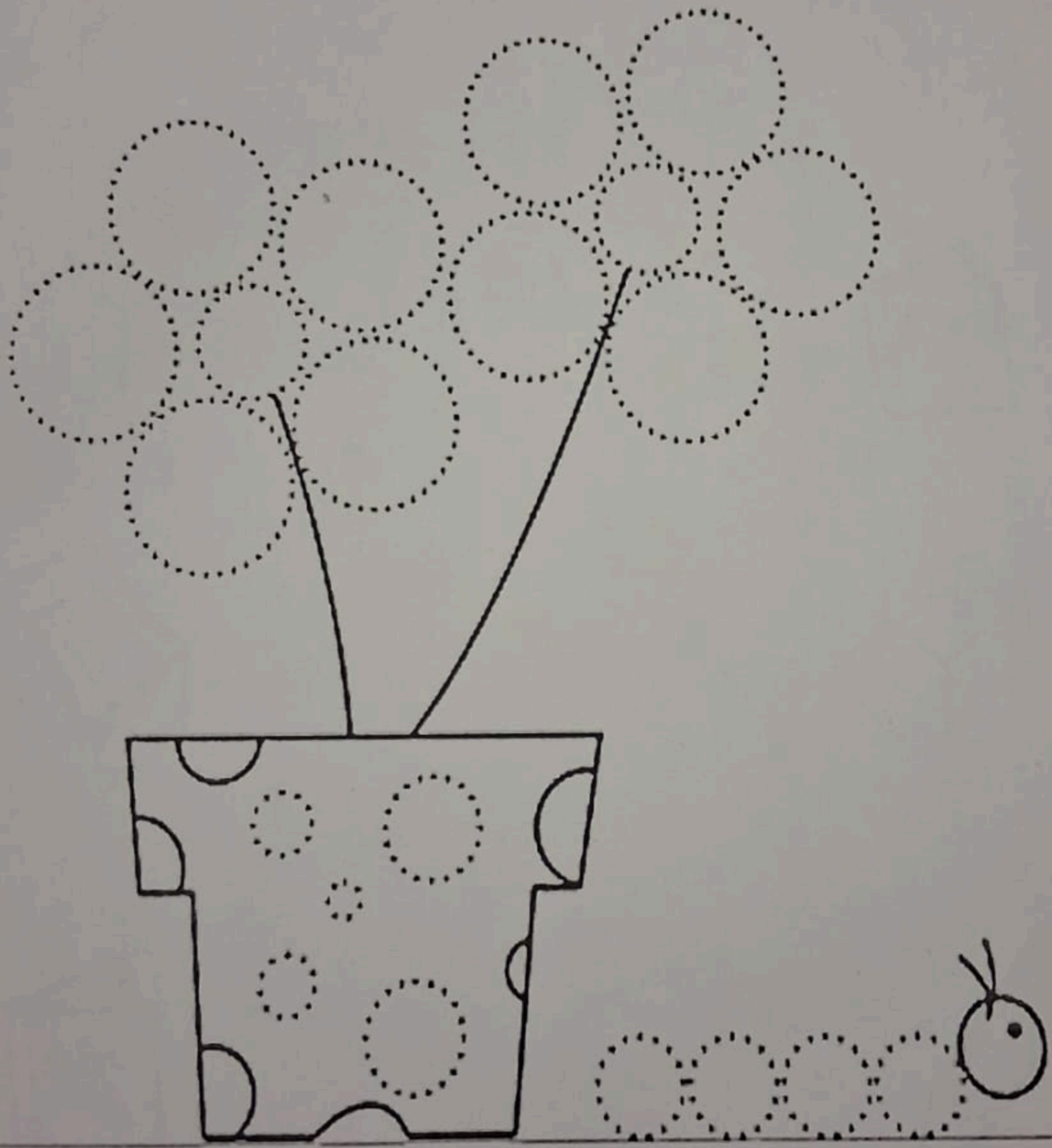

LETS PAIR THE OBJECT

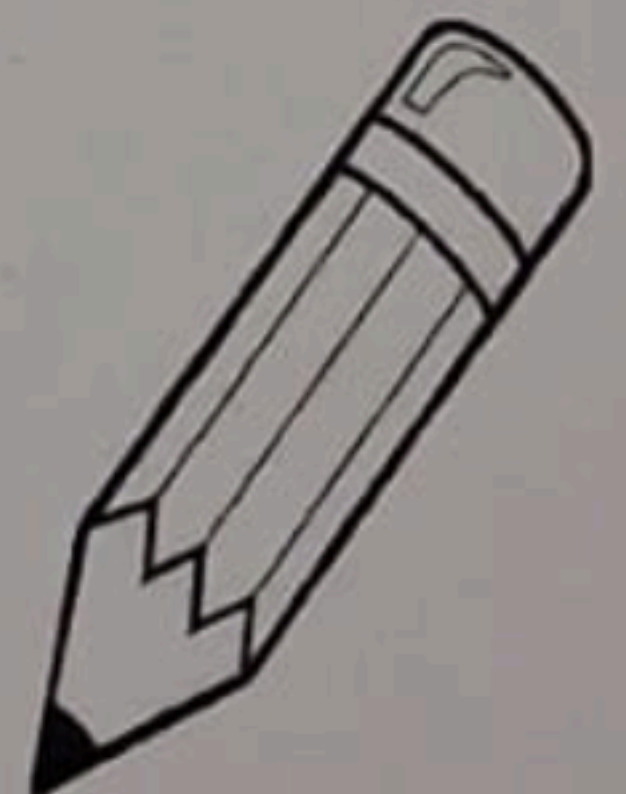
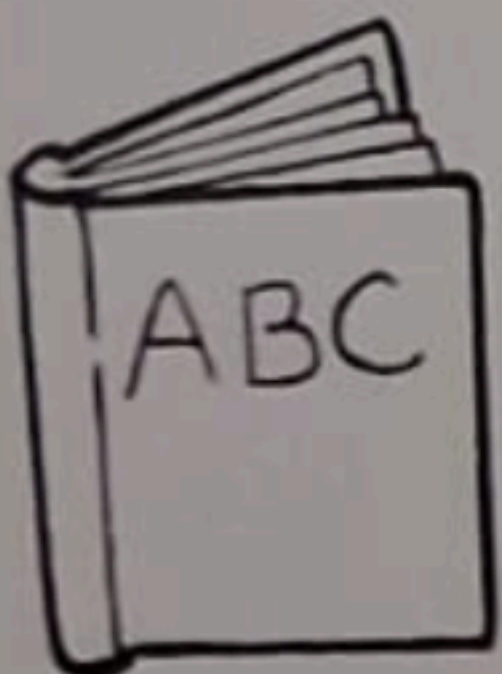
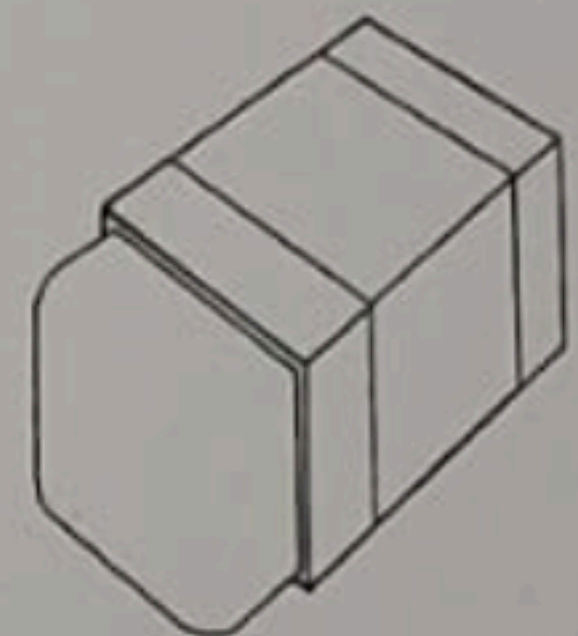
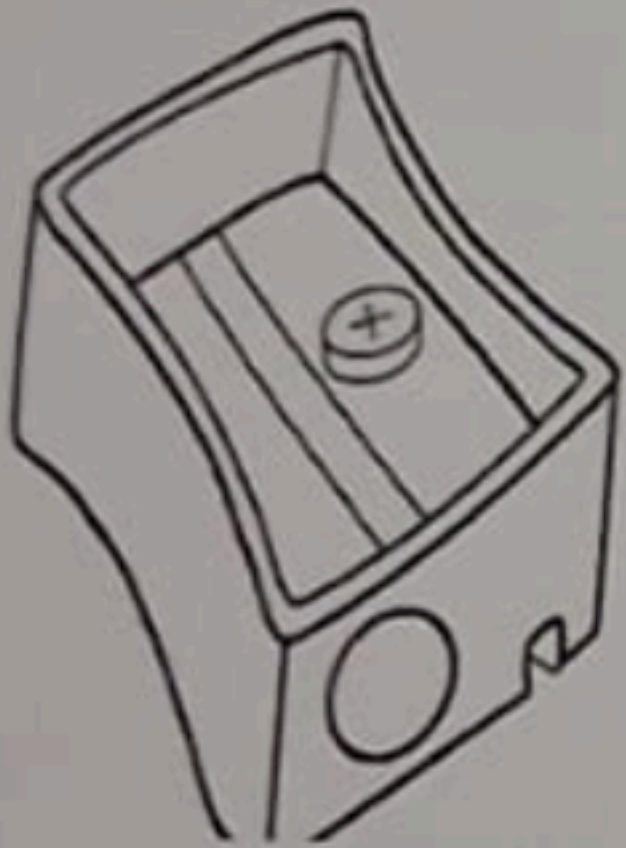
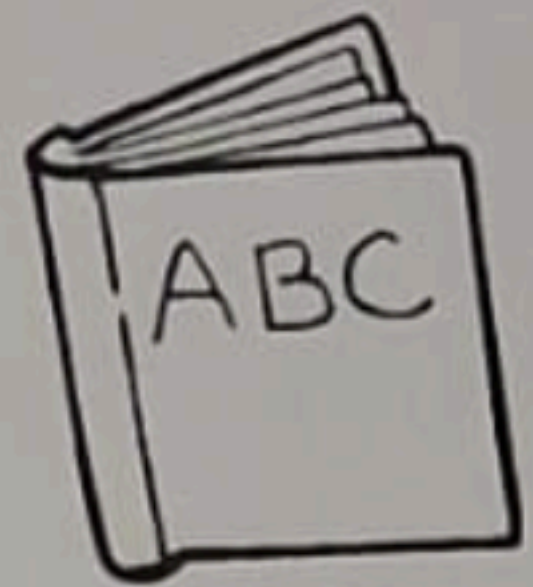
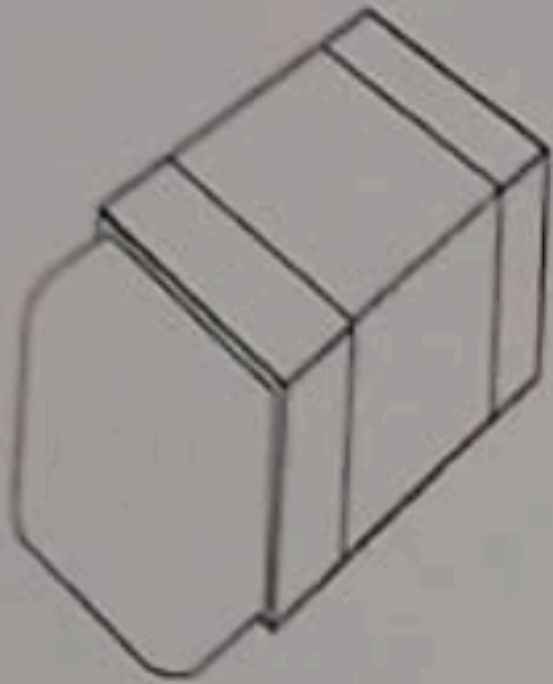
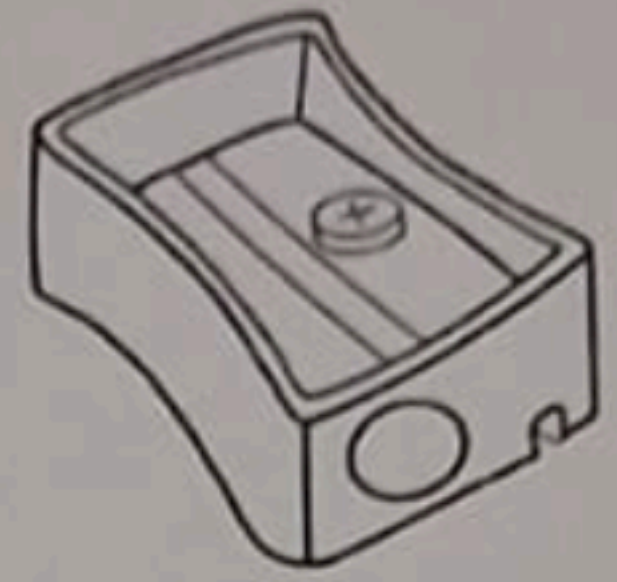

**HAPPY FATHER'S DAY**



FIND THE PATH



# FUN WITH VEGETABLE

13

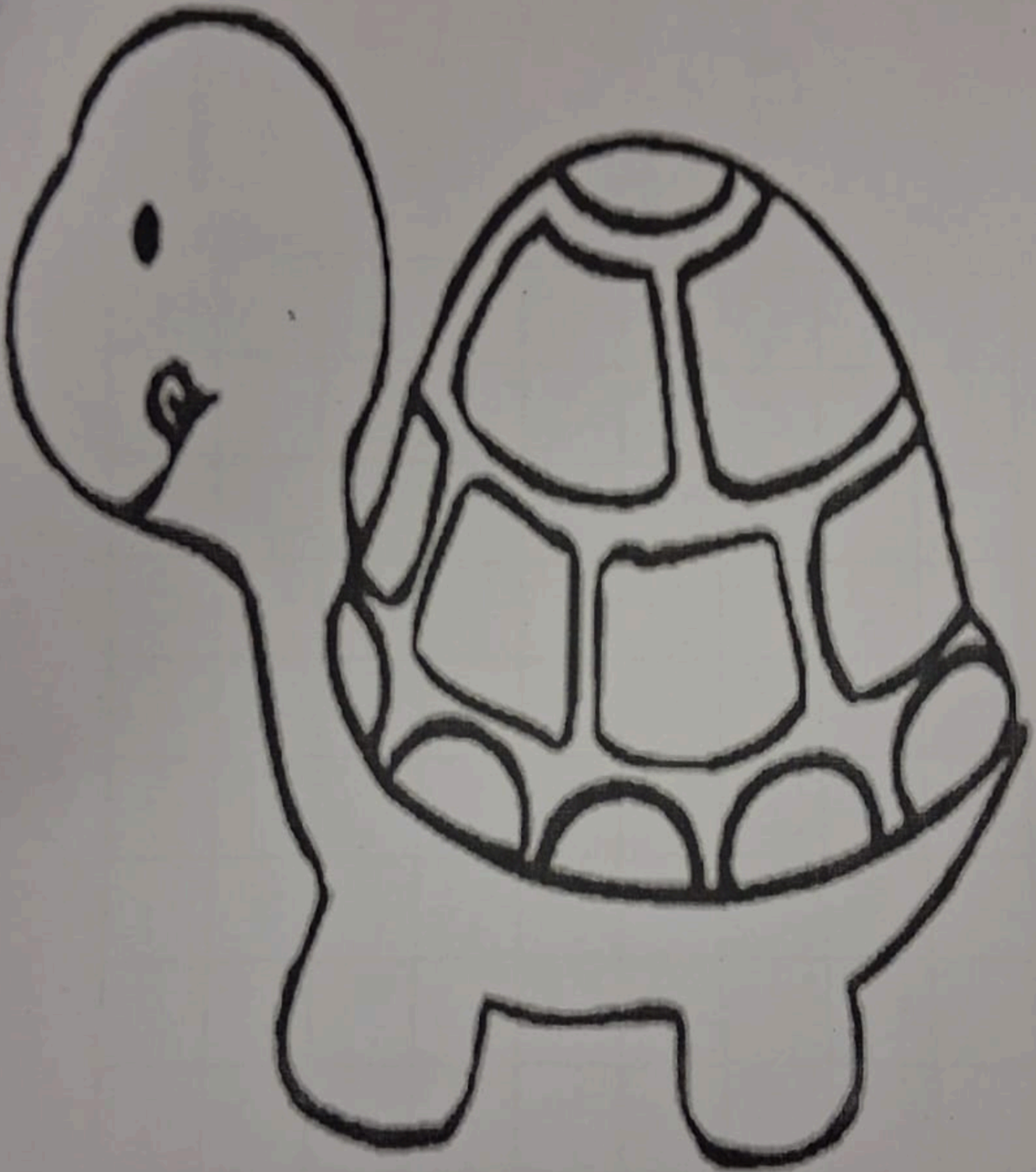





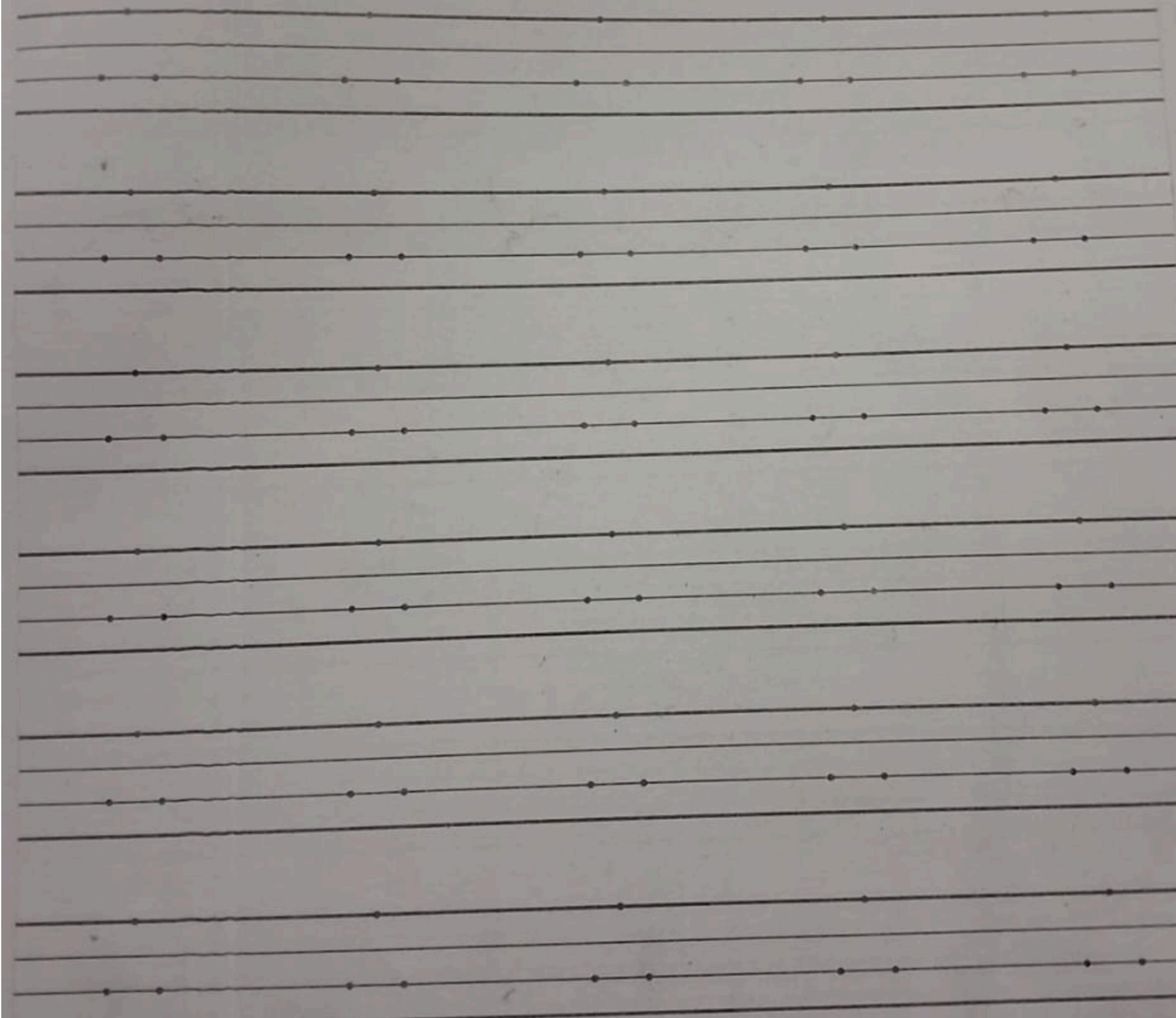
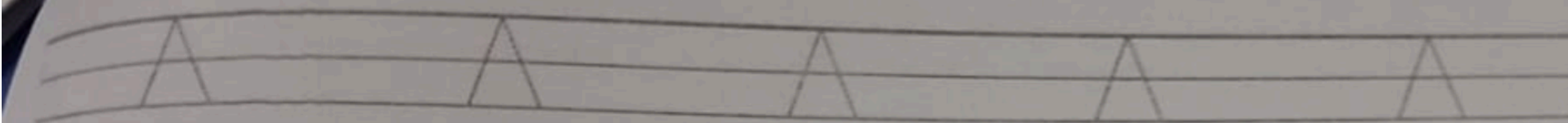
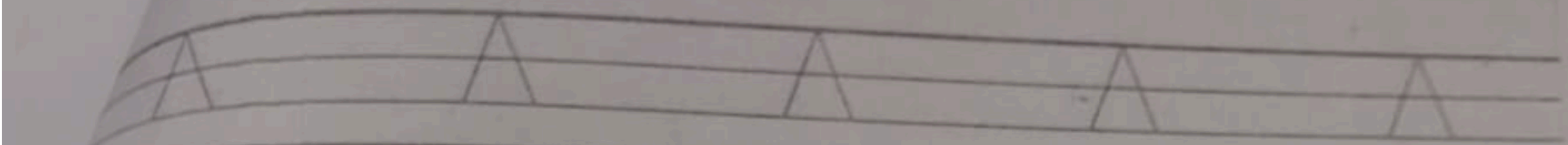

B

B

B

B

B

B

B

B

B

B

.

.

.

.

.

.

.

.

.

.

.

.

.

.

.

.

.

.

.

.

.

.

.

.

.

.

.

.

.

.

.

.

.

.

.

.

.

.

.

.

.

.

.

.

.

.

.

.

.

.

.

.

.

.

.

.

.

.

.

.